



COUNTERTOP 18" DOUGH SHEETER



Dough Sheeter, Countertop, Two (2) Sets of Rollers, Sheets up to 18" Wide, Up to 600 Pieces Per Hour, Teflon Rollers, Adjustable Roller Gap, Stainless Steel Scraper, Stainless Steel Construction, 1/2 HP Motor, cETLus, ETL-Sanitation



PROJECT _____

ITEM NO. _____

NOTES _____

MODEL NUMBER: **DL18DP**



FEATURES

- Compact Tabletop Design
- Adjustable Roller Gap Range from 1/32" (0.79mm) - 5/32" (3.9mm)
- Able to Handle Up to 18" (457mm) Product
- 1/2 HP Motor

CONSTRUCTION

- Stainless Steel Infeed & Chute
- Stainless Steel Scraper for Rollers
- Teflon Rollers
- Sealed Bearings

OPTIONS & ACCESSORIES

- CSST Conformity Kit for Quebec
- Foot Pedal
- International Electrical Configuration (208-240V/1 Phase)

RECOMMENDED USAGE

- To Be Used with Room Temperature Dough
- Dough Products Between 50-60% Hydration
- Not Designed for Fondant or Laminated Dough Products

WARRANTY

- One Year Labor & Two Year Parts

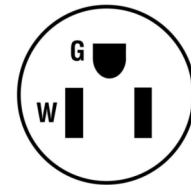
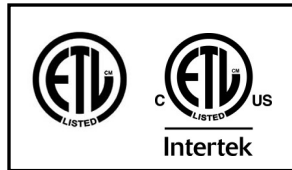
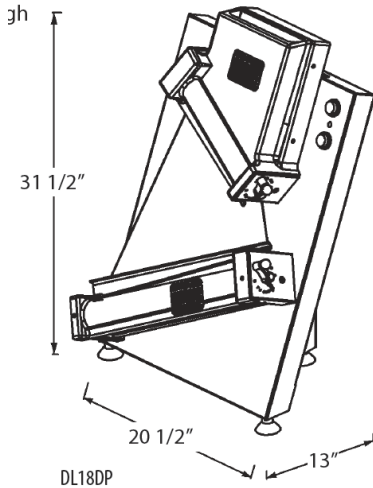

Model	Crated Weight	Overall Dimensions			Electrical System						
		W	D	H	Volts	Amps	kW	Hz	Wires	Phase	NEMA
DL18DP	100 (45)	22 1/2" (559)	13" (330)	32 1/4" (819)	120	6	0.7	60	-	1	5-15P
					208	3.4	0.7	50/60	2	1	
					240	3	0.7	50/60	2	1	

SPECIFICATIONS SUBJECT TO CHANGE WITHOUT NOTICE

KCL & REVIT DRAWINGS UPON REQUEST

REVISION A | 4/21/2021

Follow Us



Doyon

5600 13th Street, Menominee, MI 49858

906.863.4401 | 800.338.9886 | www.doyon.qc.ca

